

特点:

- 支持 Intel® 8/11th Gen Core™ i3/i5/i7 Mobile-U CPU, TDP=15/28W
- 1 个 DDR4 SO-DIMM 插槽, 最大支持 32GB
- 双 Intel® 千兆网络接口
- 2 路显示输出, HDMI、DP++
- 最多 8 个串口, 其中 6 个可支持 RS232/485
- APQ MXM、aDoor 模块扩展支持
- WiFi/4G 无线功能扩展支持
- 12~24V 直流供电(可选 12V)
- 超紧凑机身、可选多种安装方式



远程管理



状态监控



远程运维



安全控制

产品规格

Model		TAC-6010	TAC-6020
CPU	CPU	Intel 8/11 th Generation Core™ i3/i5/i7 Mobile -U CPU, TDP=15/28W	
	Chipset	SOC	
BIOS	BIOS	AMI UEFI BIOS	
	Socket	1 * DDR4-2400/2666/3200 MHz SO-DIMM Slot	
Memory	Max Capacity	32GB	
	Controller	Intel® UHD Graphics/Intel® Iris® Xe Graphics Note: Graphics controller type depend on CPU model	
Ethernet	Controller	1 * Intel® i210-AT (10/100/1000 Mbps, RJ45) 1 * Intel® i219 (10/100/1000 Mbps, RJ45)	
	Storage	1 * M.2 Key-M Slot (PCIe x4 NVMe/ SATA SSD, auto detect, 2242/2280)	
Expansion Slots	M.2	1 * M.2 Key-B Slot (USB2.0, Support 4G, 3042, only for 12V version) 1 * Mini PCIe Slot (PCIe+USB2.0, only for 12~24V version)	
	Mini PCIe	1 * Mini PCIe Slot (SATA/PCIe+USB2.0)	
	MXM/aDoor	N/A	1 * MXM (support APQ MXM 4 * LAN/6 * COM/16 * GPIO expansion card) Note: 11 th CPU don't support MXM expansion 1 * aDoor Expansion I/O
Front I/O	USB	4 * USB3.0 (Type-A) 2 * USB2.0 (Type-A)	
	Ethernet	2 * RJ45	
	Display	1 * DP: max resolution up to 3840*2160@24Hz 1 * HDMI (Type-A): max resolution up to 3840*2160@24Hz	
	Serial	4 * RS232/485 (COM1/2/3/4, jumper control)	4 * RS232/485 (COM1/2/3/4/7/8, jumper control) 2 * RS232 (COM9/10) Note: 11 th CPU don't support COM7/8/9/10
Right I/O	SIM	2 * Nano SIM Card Slot (Mini PCIe modules provide functional support)	
	Audio	1 * 3.5mm Jack (Line-Out + MIC, CTIA)	
	Power	1 * Power Button 1 * PS_ON 1 * DC Power Input	
Power Supply	Type	DC	
	Power Input Voltage	12~24VDC (optional 12VDC)	
	Connector	1 * 4Pin Power Input Connector (P= 5.08mm)	
	RTC Battery	CR2032 Coin Cell	
OS Support	Windows	Windows 10	
	Linux	Linux	
Watchdog	Output	System Reset	
	Interval	Programmable 1 ~ 255 sec	
Mechanical	Enclosure Material	Radiator: Aluminum, Box: SGCC	
	Dimensions	165mm(L) * 115mm(W) * 64.5mm(H)	165mm(L) * 115mm(W) * 88.2mm(H)
	Weight	Net: 1.2kg, Total: 2.2kg	Net: 1.4kg, Total: 2.4kg
	Mounting	DIN, Wallmount, Desk mounting	
Environment	Heat Dissipation System	Passive Heat Dissipation (8 th CPU) PWM Air Cooling (11 th CPU)	
	Operating Temperature	-20~60℃	
	Storage Temperature	-40~80℃	
	Relative Humidity	5 to 95% RH (non-condensing)	
	Vibration During Operation	With SSD: IEC 60068-2-64 (3Grms@5~500Hz, random, 1hr/axis)	
	Shock During Operation	With SSD: IEC 60068-2-27 (30G, half sine, 11ms)	
Certification	CE		

产品尺寸

TAC-6010

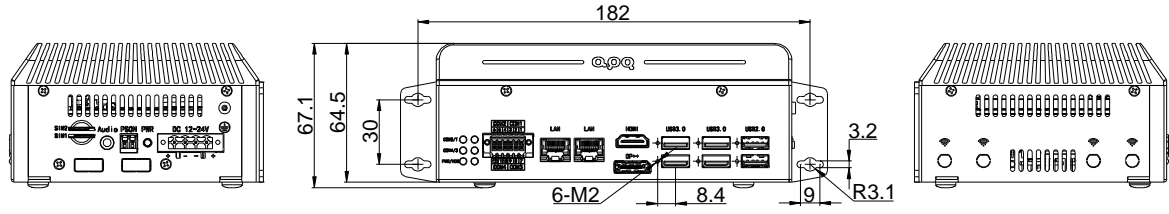

TAC-6020

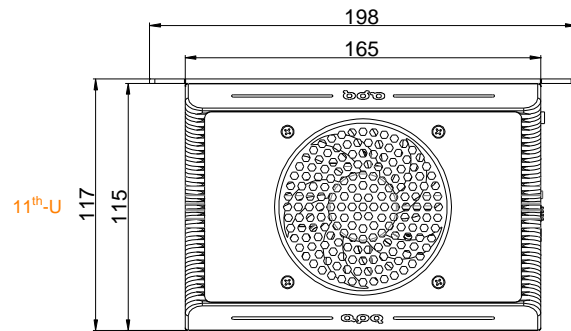
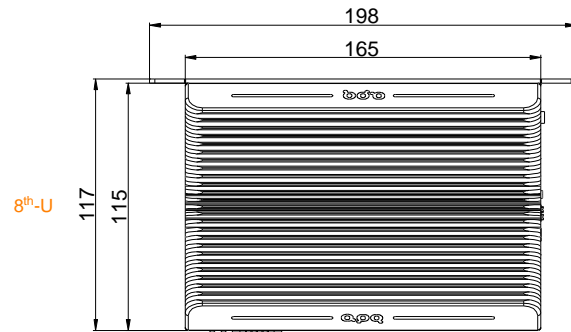
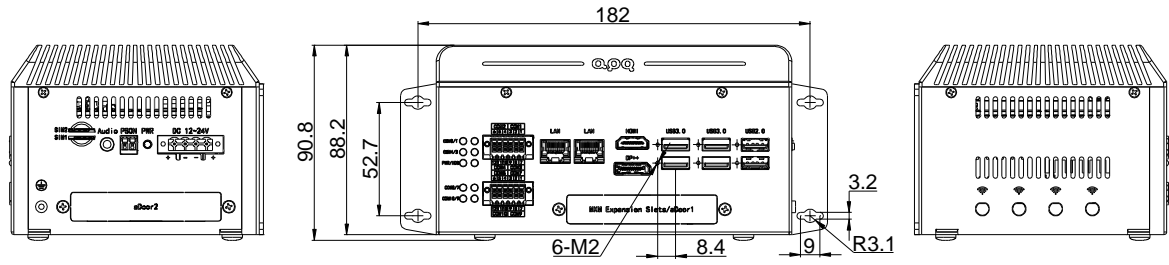

产品 I/O

TAC-6010

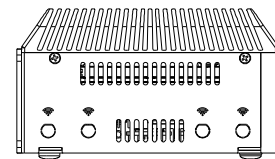
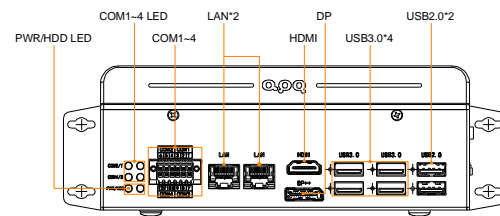
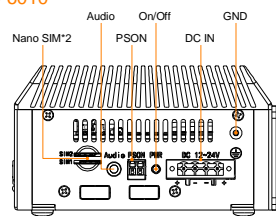

TAC-6020

